

Plata Mate 12	Inox. Repulido 24	Lacado Blanco 30	Blanco Mate Texturado 33	Cris 7022 34
Bleu 600 Sable 41	Marrón Mate CA 42	Pino Envejecido Texturado 53	Fiammato Oscuro P.s.P 92	

La representación de los colores es orientativa y puede haber diferencias con el original

C/Joaot Martorell S/N
Pol. Ind. Jordi Camp
08403 GRANOLLERS (Barcelona)
T. 938604216
Fax 938604217

info@aluminiosvalverde.es
www.aluminiosvalverde.es



Pensada para los amantes del espacio y de la luz, sin olvidar la elegancia de sus líneas.

**Corredera
fría
Panorámica**

Transmitancia térmica

$U_w = 2,0 \text{ W/m}^2\cdot\text{K}$

Dimension 1480x2180
(vidrio 1,1 $\text{W/m}^2\cdot\text{K}$)

Permeabilidad al aire CLASE 3

Estanquidad al agua CLASE 8A

Resistencia a la carga del viento CLASE C4

Aislamiento acústico

28 a 30 dB

Según acristalamiento

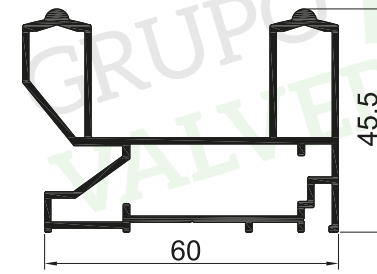
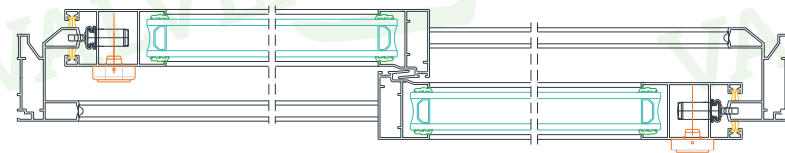

Marco 60 Ref. 44.1160

CARACTERÍSTICAS:

- Sección de marco: 60
- Sección de hoja: 39
- Máximo hueco acristalar: 32

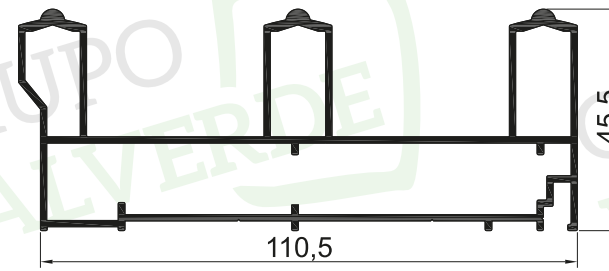

Marco 3 carriles Ref. 44.1500

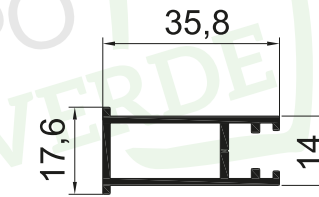

Acople 3/4 hojas Ref. 68.6500

TIPOS DE APERTURA

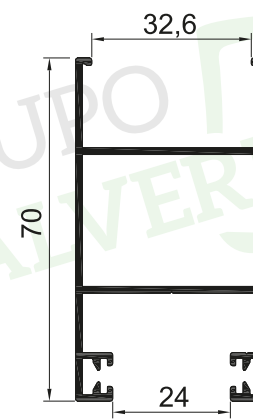
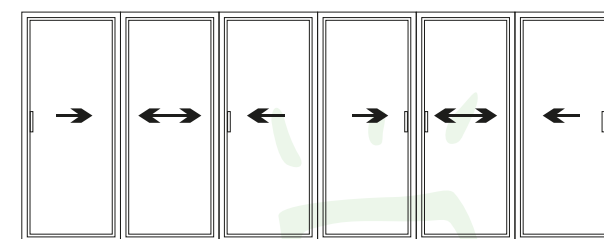
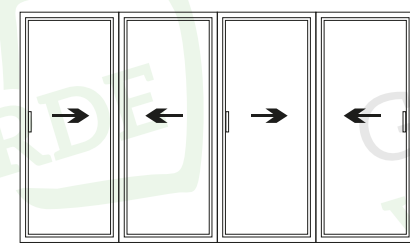
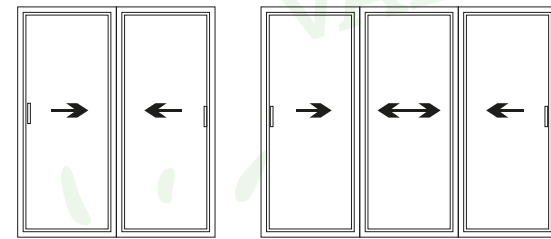

Hoja lateral Ref. 44.2170

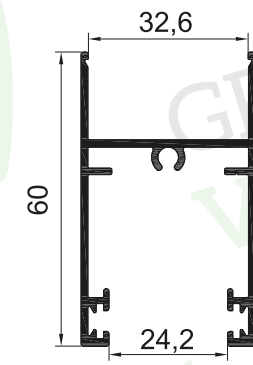

Casaca Ref. 44.2270

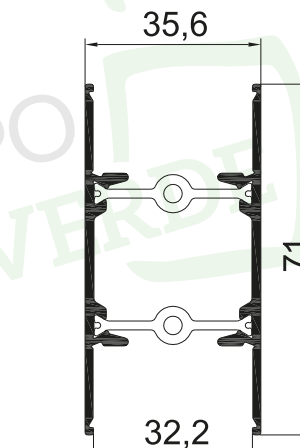

Travesaño hoja Ref. 68.2470

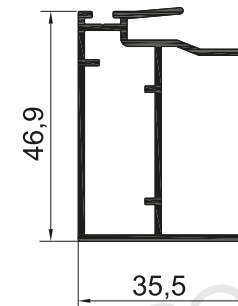

Cruce ventana Ref. 44.2370

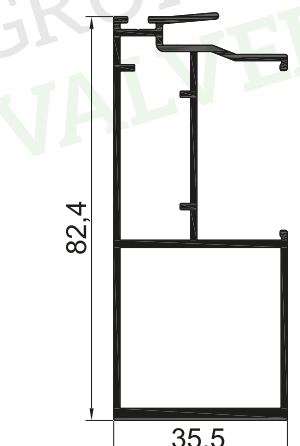

Cruce balconera Ref. 44.2371

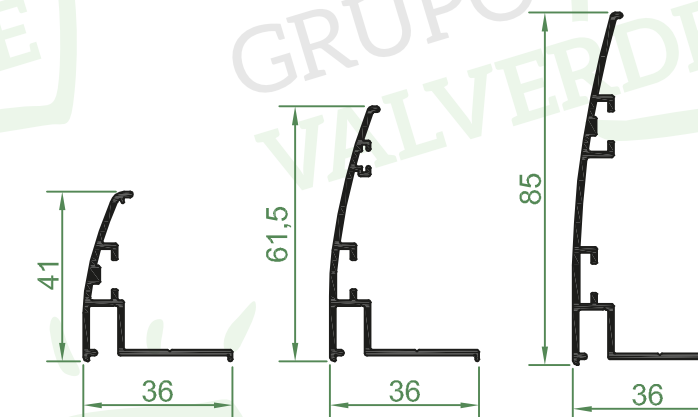

35.5340

35.5360

35.5385

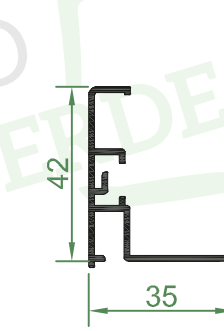

35.5640

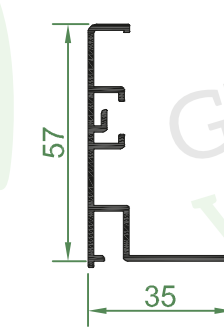

35.5660

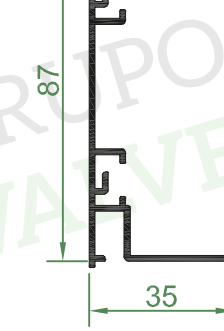

35.5685

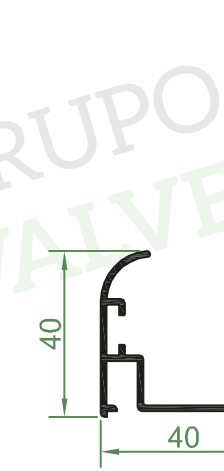

35.1024

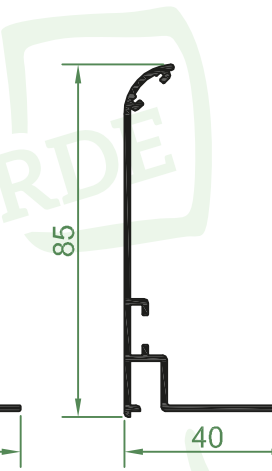

35.1023

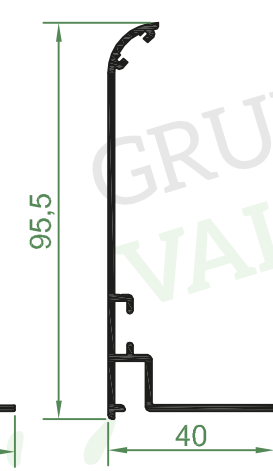

35.1033

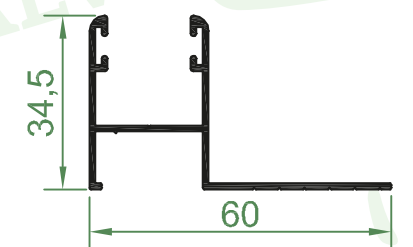

41.1560